

**CONSEW** *Since 1898* ®

**MODEL 287RB**

**PARTS BOOK**



# I N D E X

|  |    |
|--|----|
| Thread take up lever,needle bar for all models. . . . .                                  | 1  |
| Lifting lever, slide plate for all models . . . . .                                      | 2  |
| Thread tension,feed driving rock shaft,<br>feeder, needle plate for all models . . . . . | 3  |
| Presser bar,lifting rock shaft,<br>vibrating presser foot for all models . . . . .       | 4  |
| Hook driving shaft,rotating hook,<br>timing belt for all models . . . . .                | 5  |
| Reverse stitch mechanism for all models . . . . .  | 6  |
| Special parts for LCW-8BLV. . . . .  | 7  |
| Face plate,oil regulation for all models. . . . .  | 8  |
| Belt guard. . . . .  | 9  |
| Accessories . . . . .  | 10 |
| Feed mechanism for LCW-8BL-1. . . . .  | 12 |
| Feed mechanism for LCW-8BLV-1 . . . . .  | 13 |

天秤・針棒関係

1

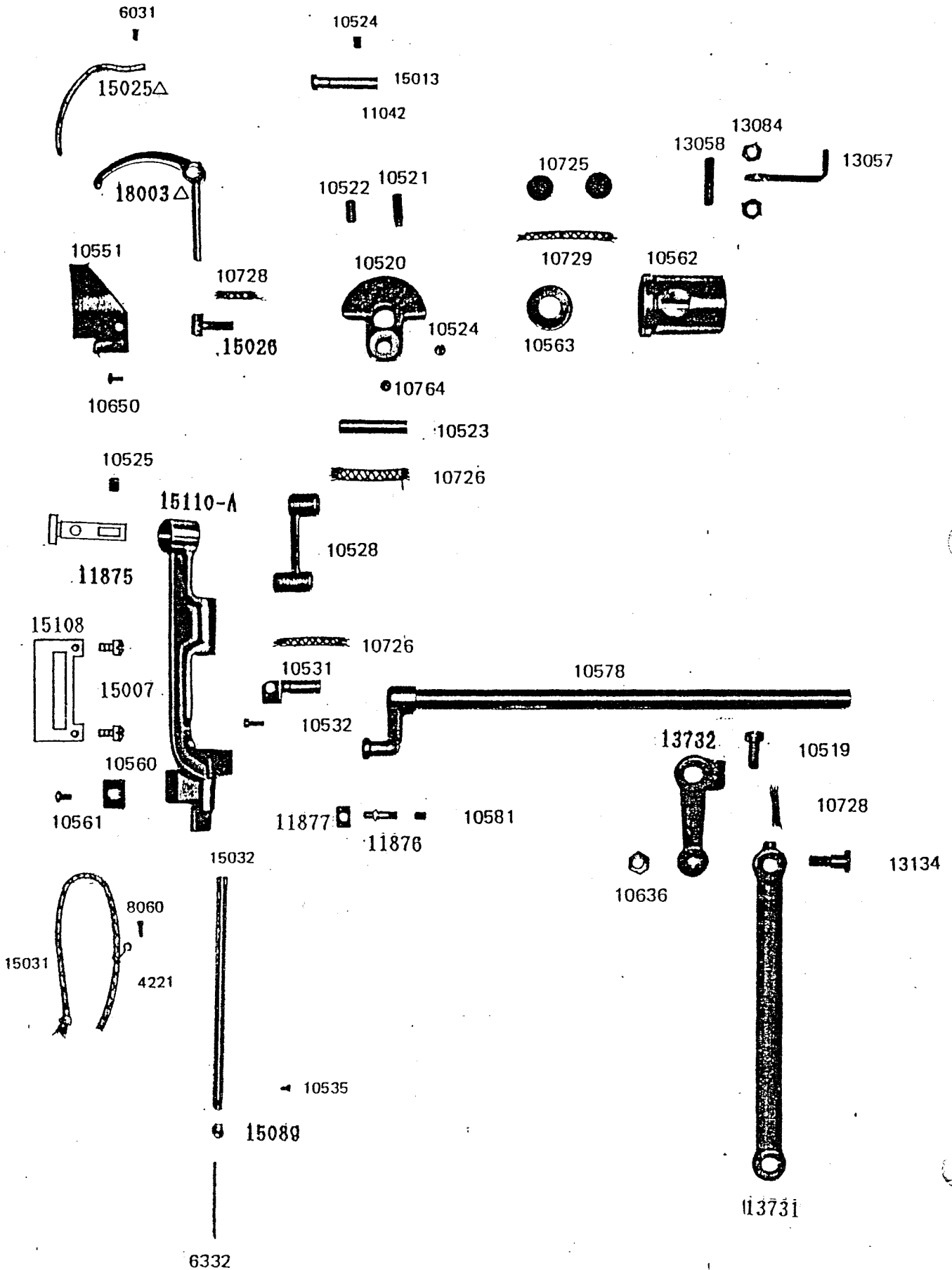

10712

13058-A



13059

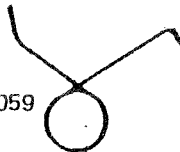

11156



10705

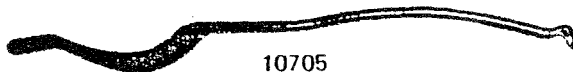

15035

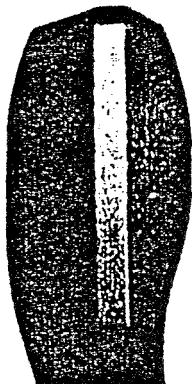

15038



15036



15039



15037



15039

13026

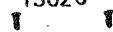

13704

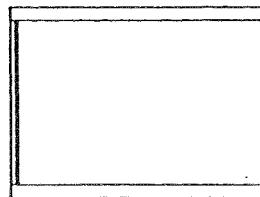

13827

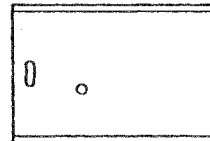

13707

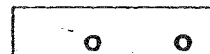

13705

13026

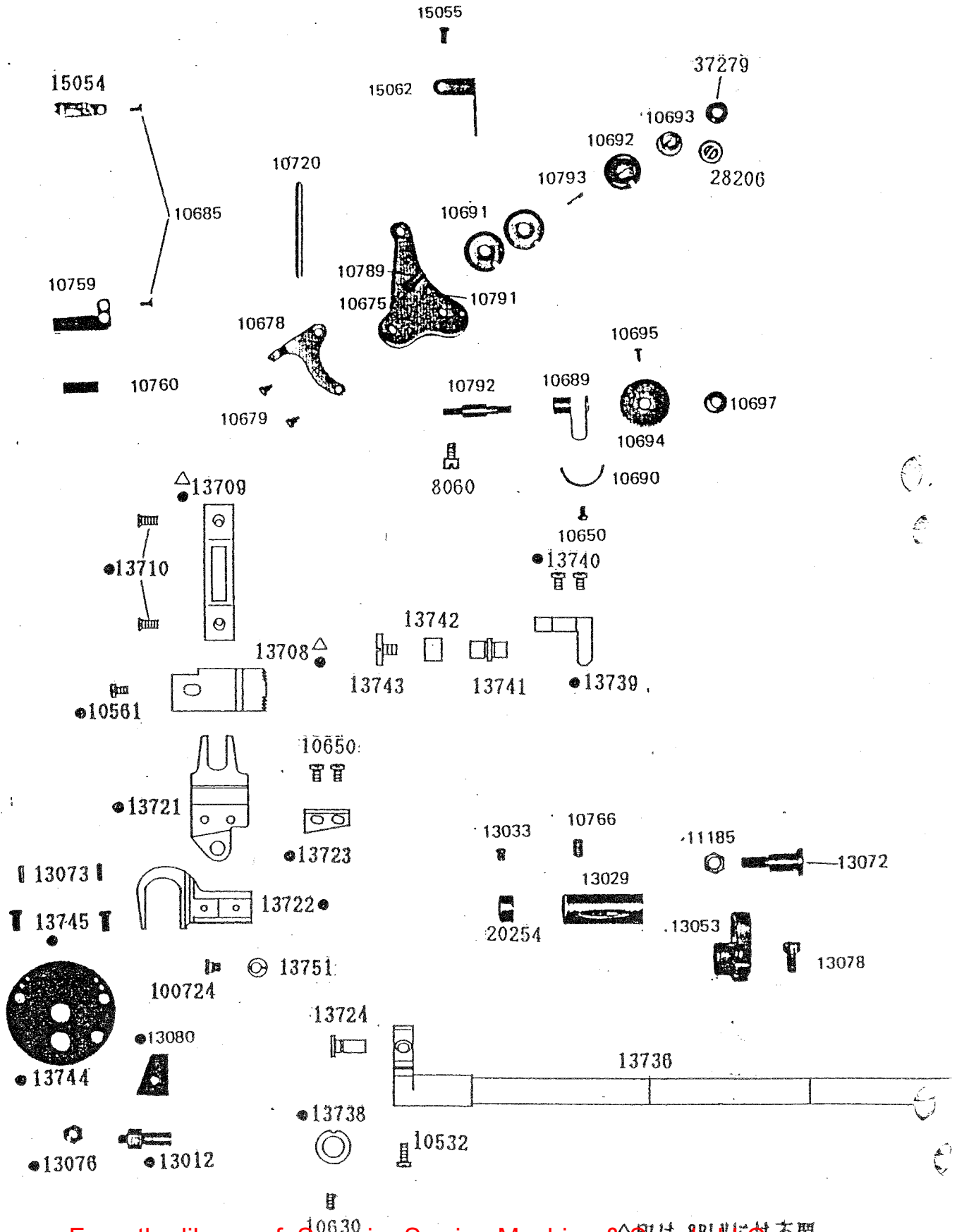

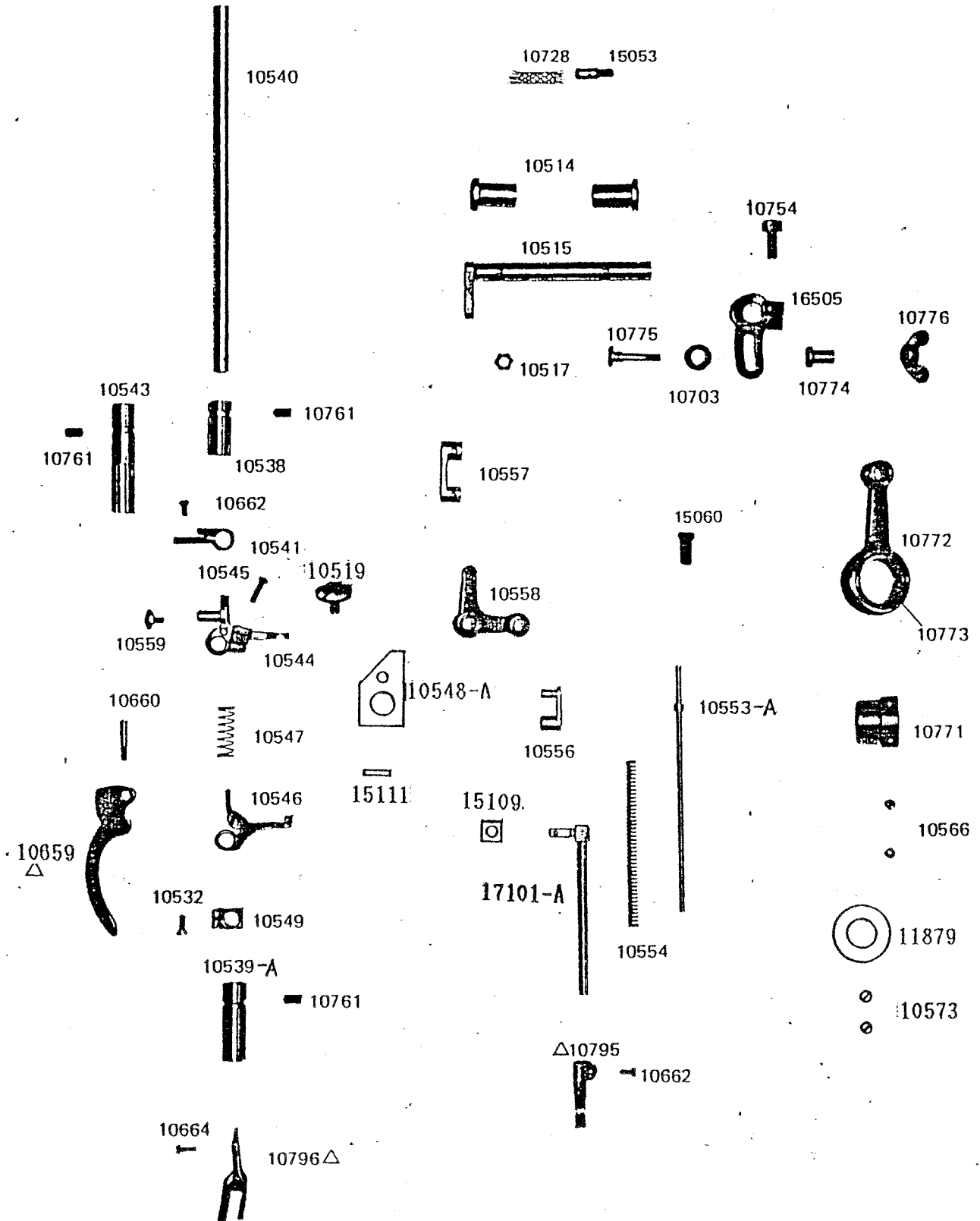

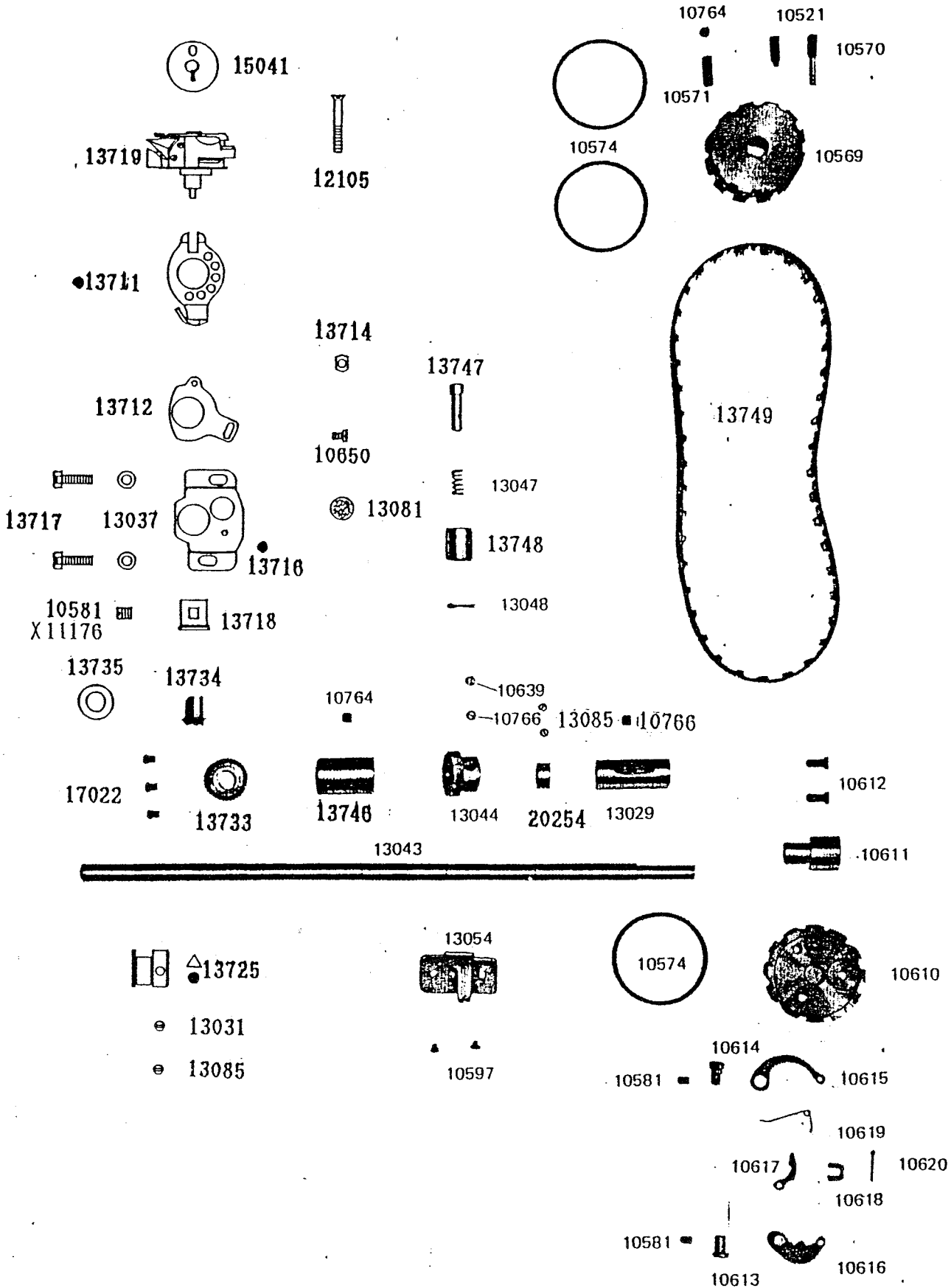



# LCW-8BL-1 FEED MECHANISM

LCW-8BL-1

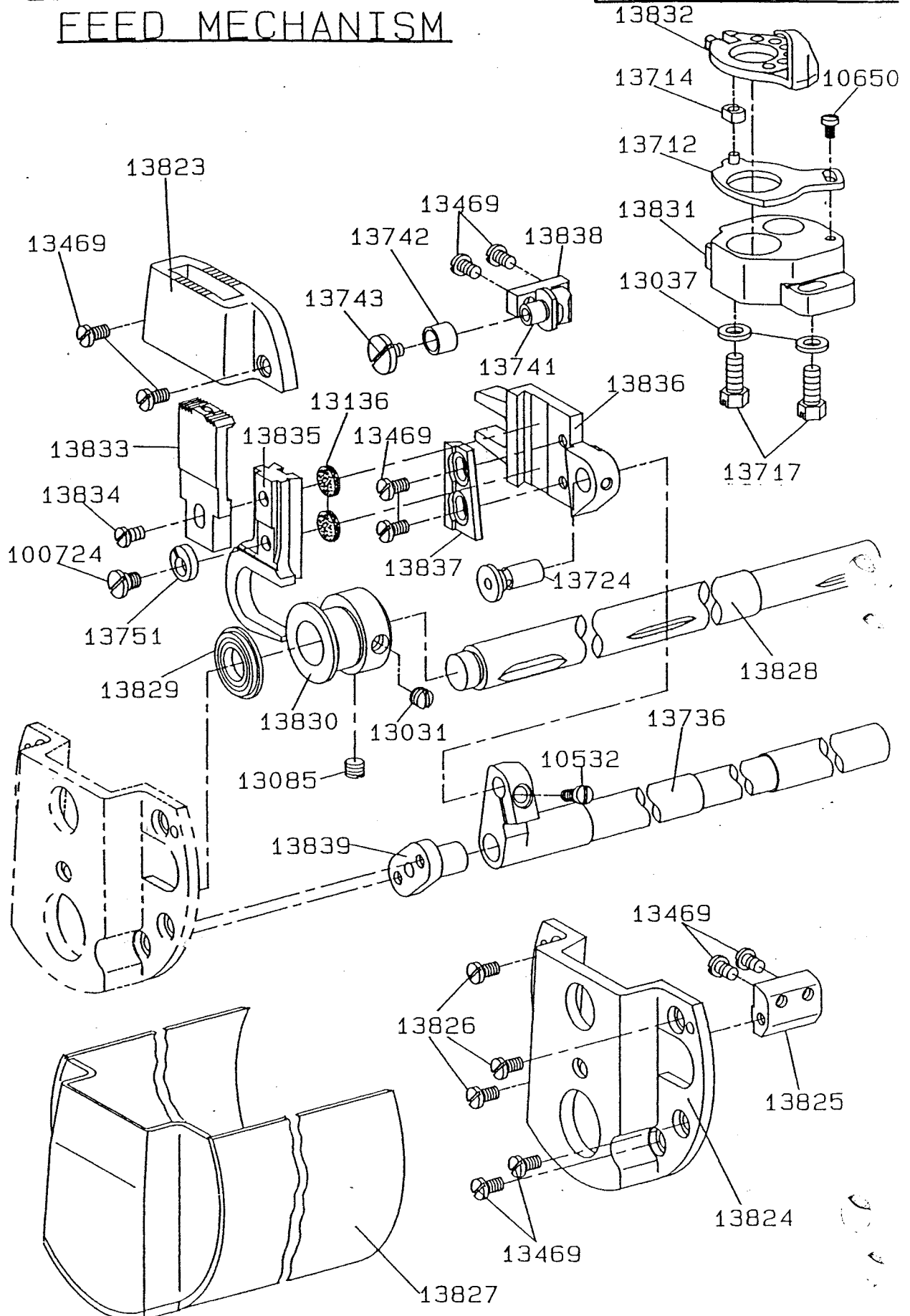

# LCW-8BLV-1 FEED MECHANISM

# LCW-8BLV-1

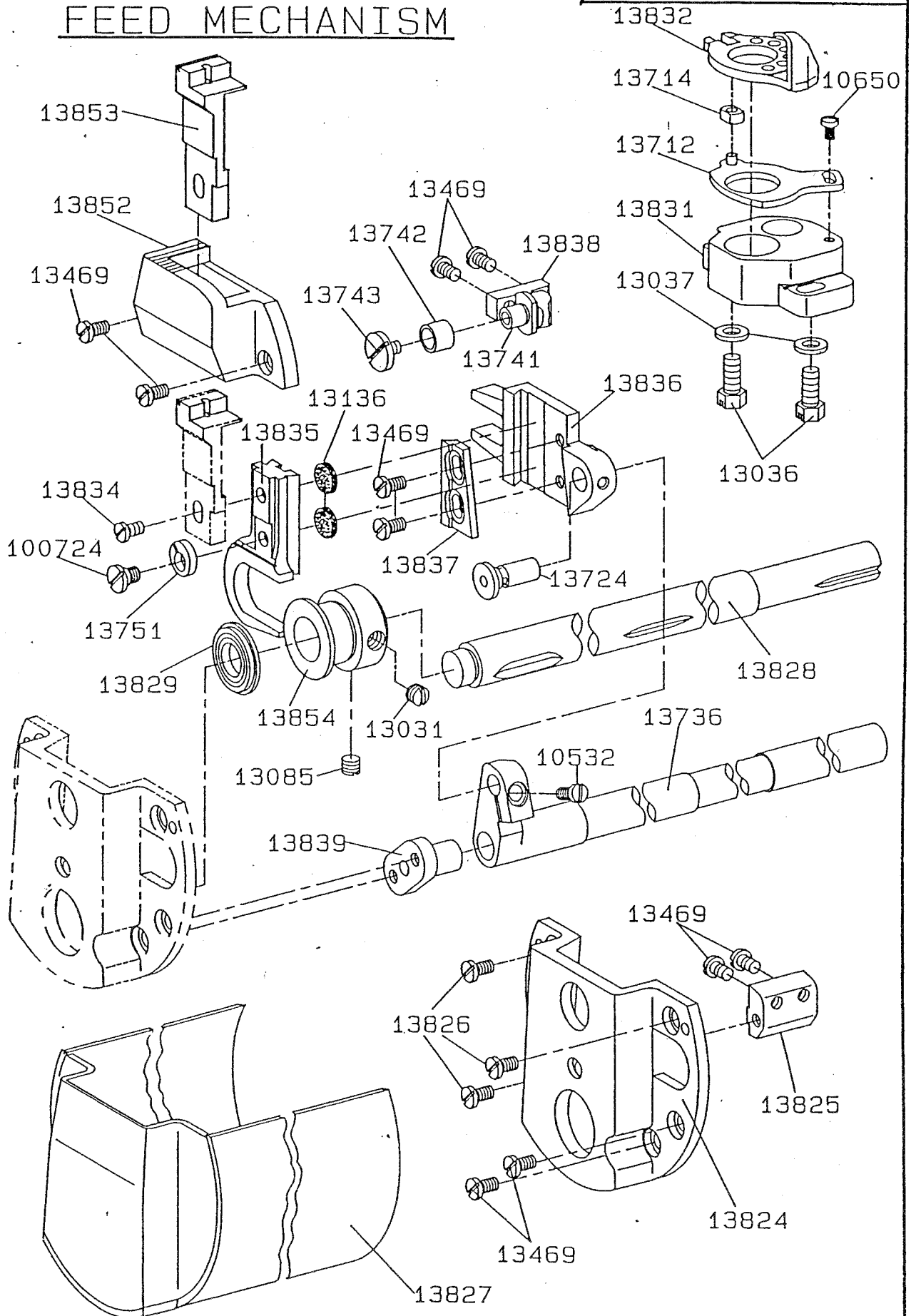

1017

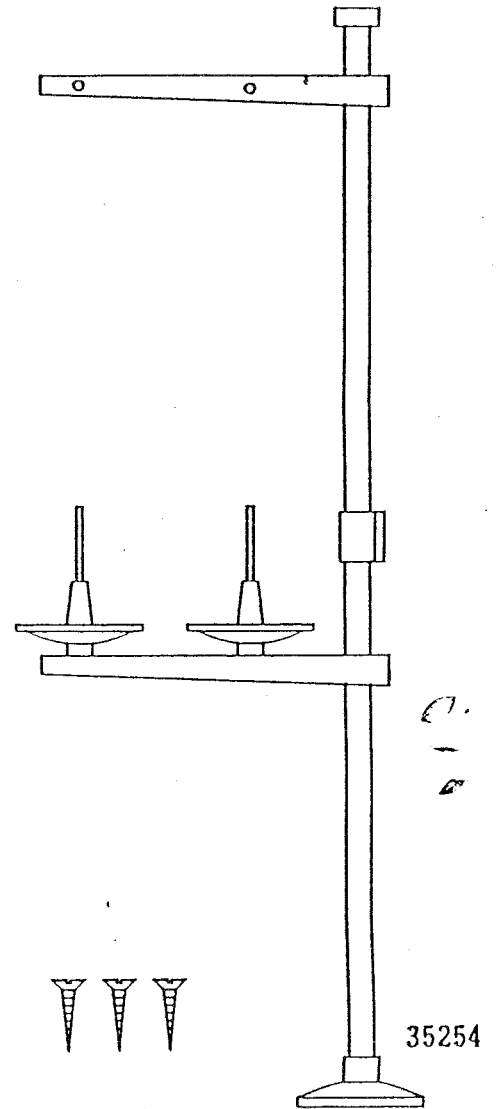
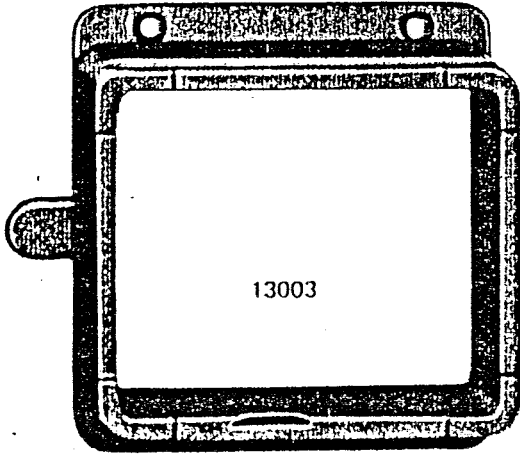
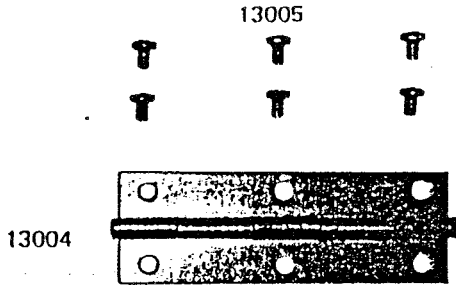

1018

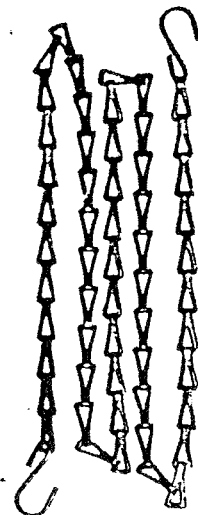
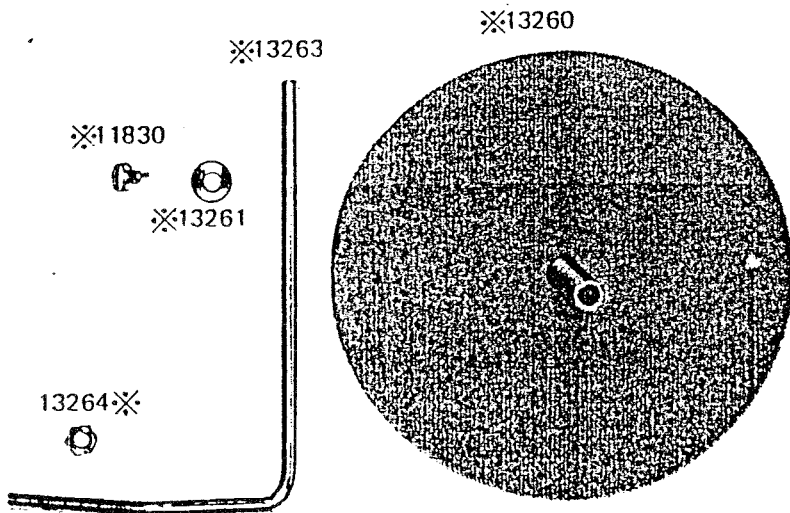

1019



8132

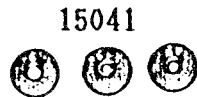

15041



6332



10748

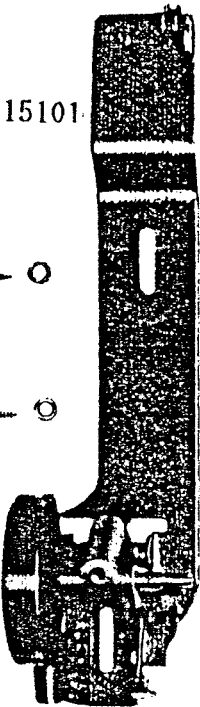

15101



8118



8120



8121

11969



50285

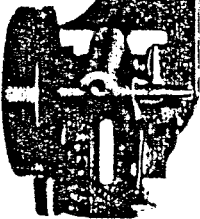

13094



8125

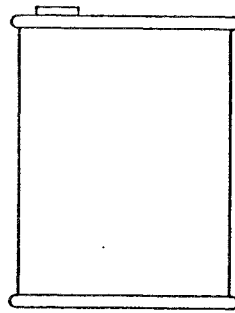

11193

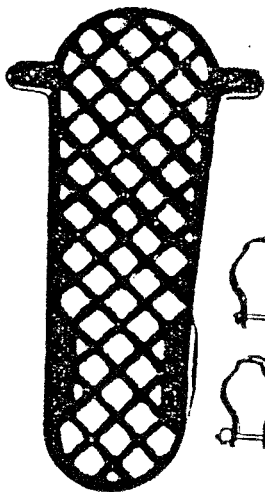

8124



13096

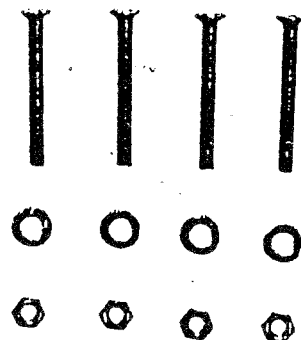

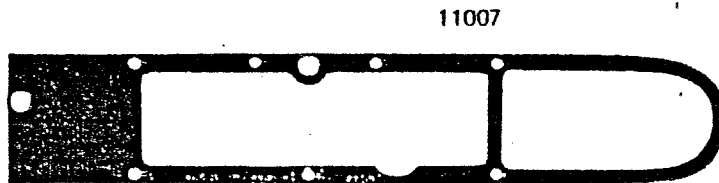
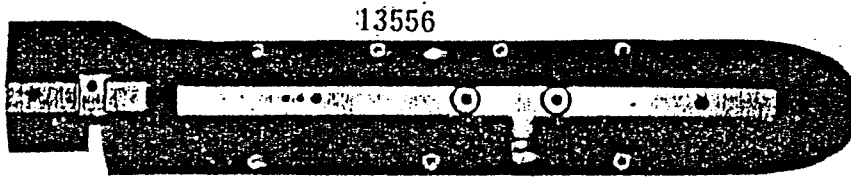
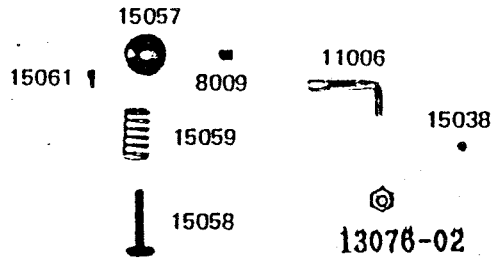

15004

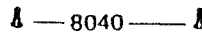
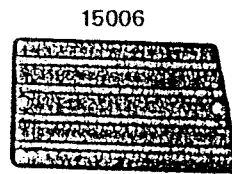
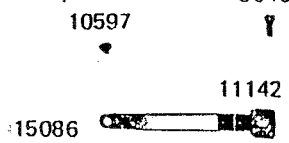
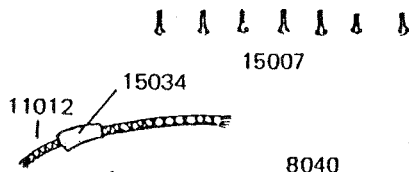

13426

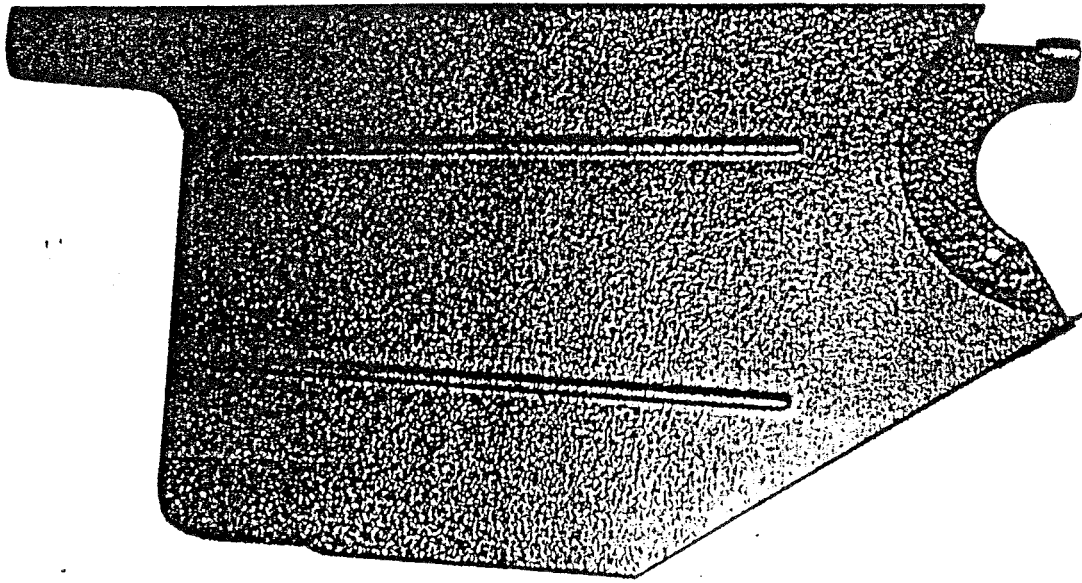

13427



50103



50099



114024



6339



11142



10561

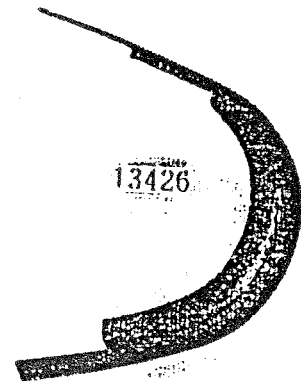

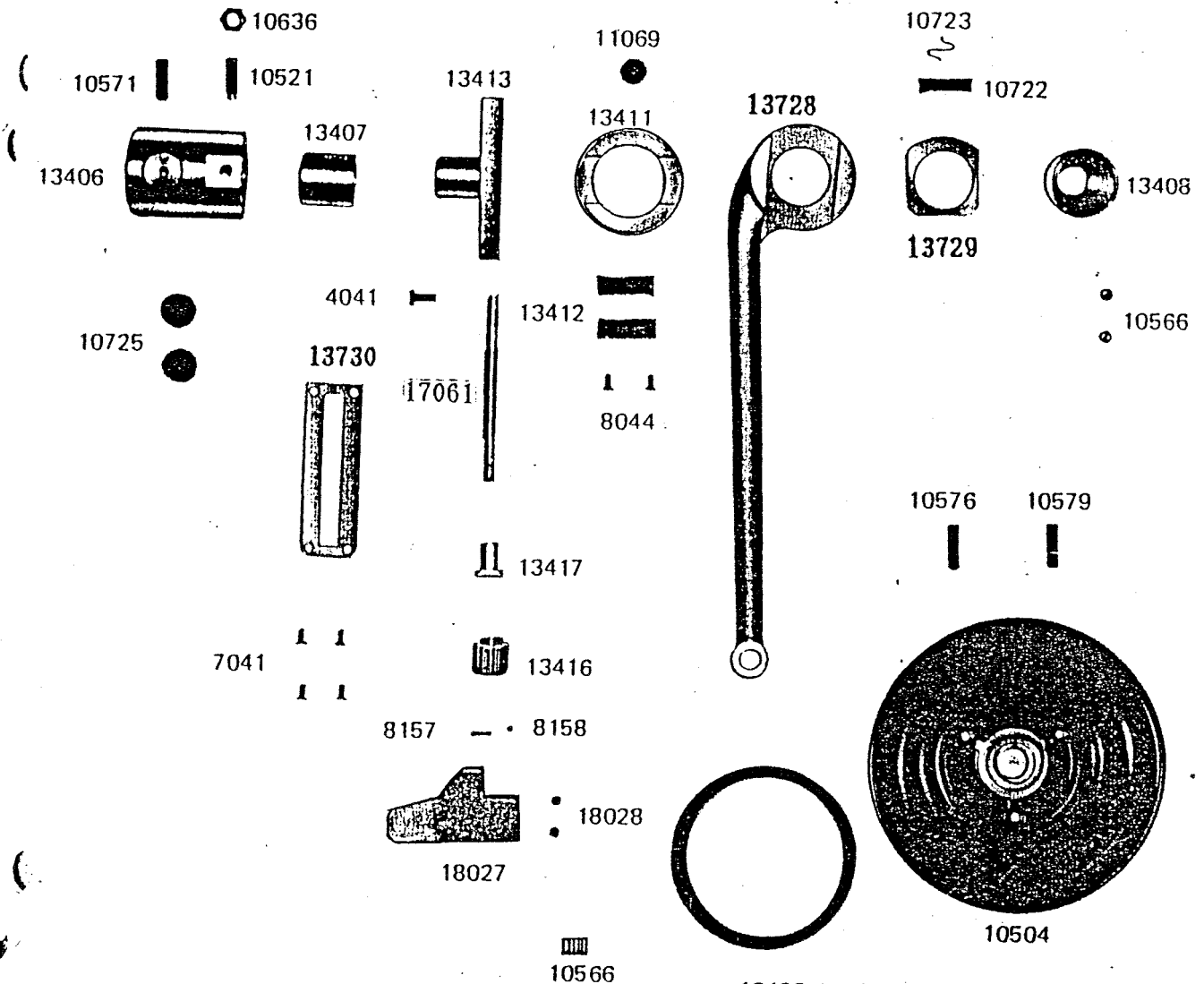
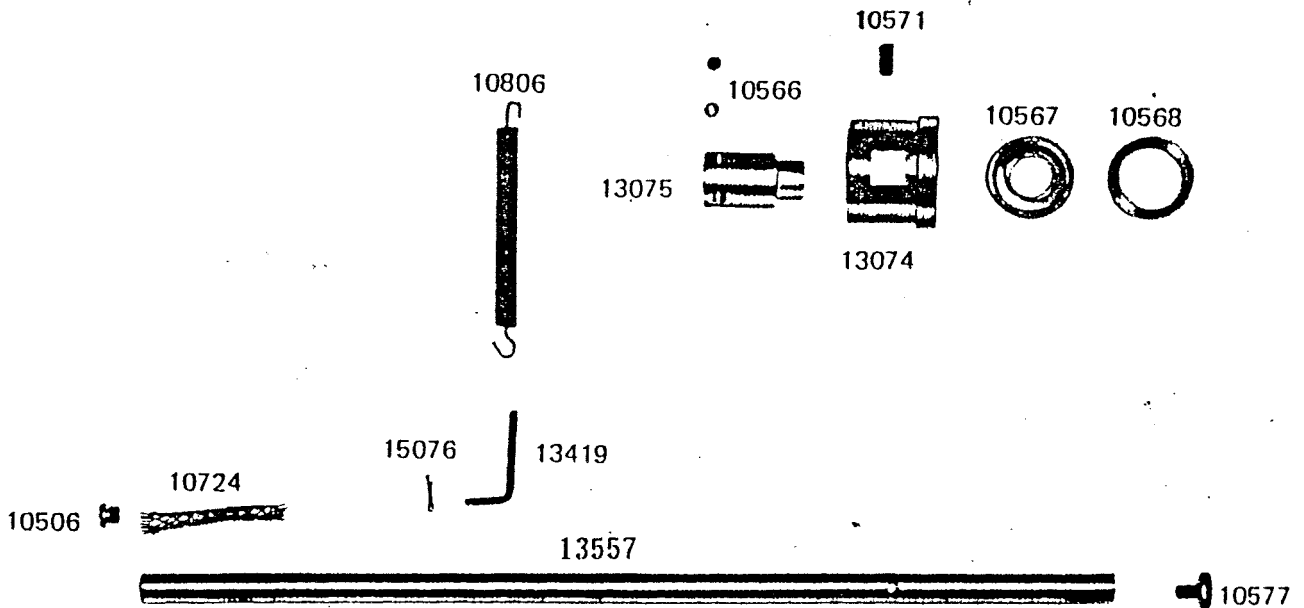

13423 A ... Use with guard A ... ガード付用

B ... Use without guard B ... ガード無用

7

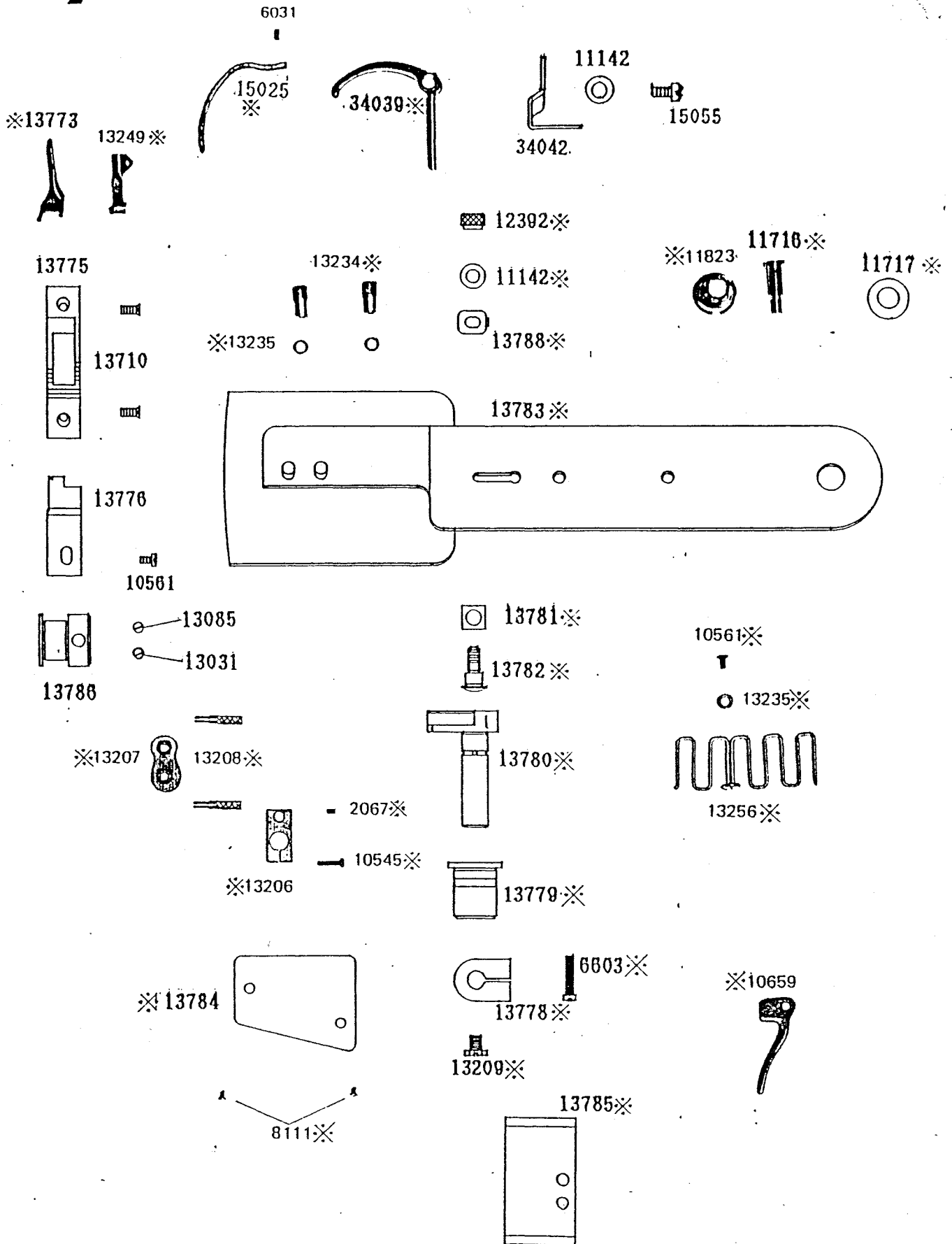





# **Consolidated Sewing Machine Corp.**

## **MAIN OFFICE**

131 West 25th Street  
New York, NY 10001  
Tel: (212) 741-7788  
Fax: (212) 741-7787

## **BRANCH OFFICE**

7855 NW 29th Street, Bay 166  
Miami, FL 33122  
Tel: (305) 471-0200  
Fax: (305) 471-0243